

Slender LED Highbay Light



CE **RoHS** **IP65** **IK09**

Features:

- With easy clean and maintenance characteristics
- High energy savings compared to systems with traditional discharge lamps
- Light-on-demand feature with optional motion sensor
- Robust design
- Emergency lighting with optional battery
- High visual comfort
- No hazardous materials
- Fast ROI thanks to long life span and reduced maintenance
- Compact housing optimised for heat dissipation and reduced dust accumulation

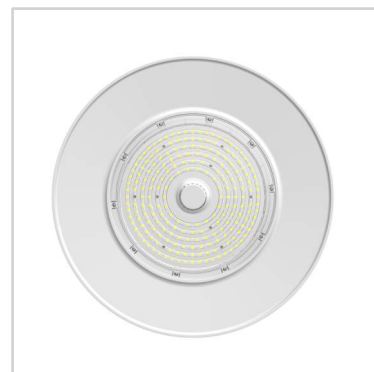
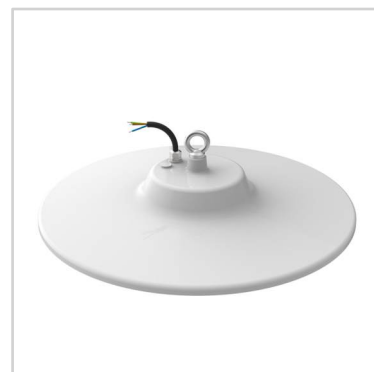

Slender LED Highbay Light Specification

Slender LED Highbay Light

Dimension

80W

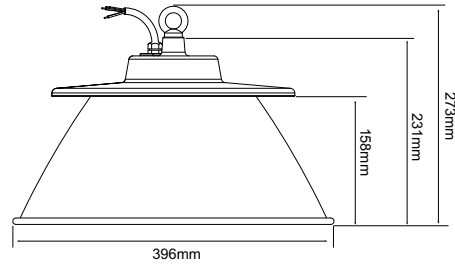
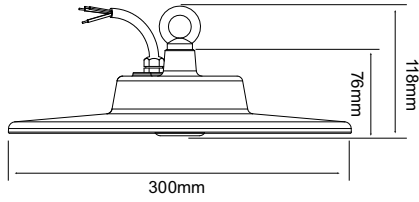

120W

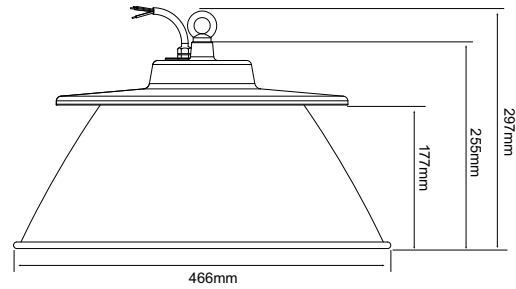
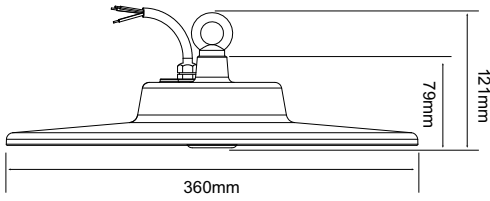

160W

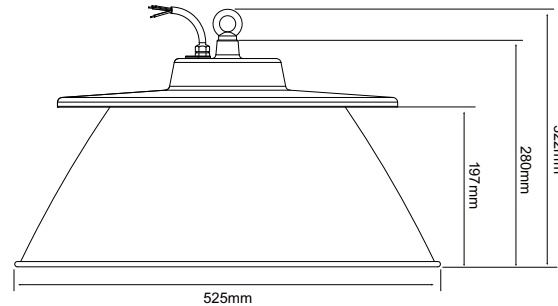
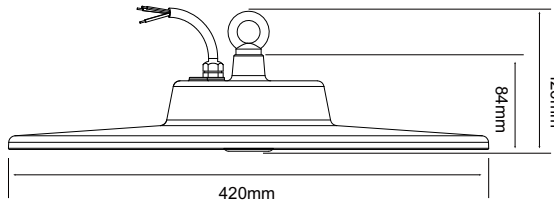

Light Distributions

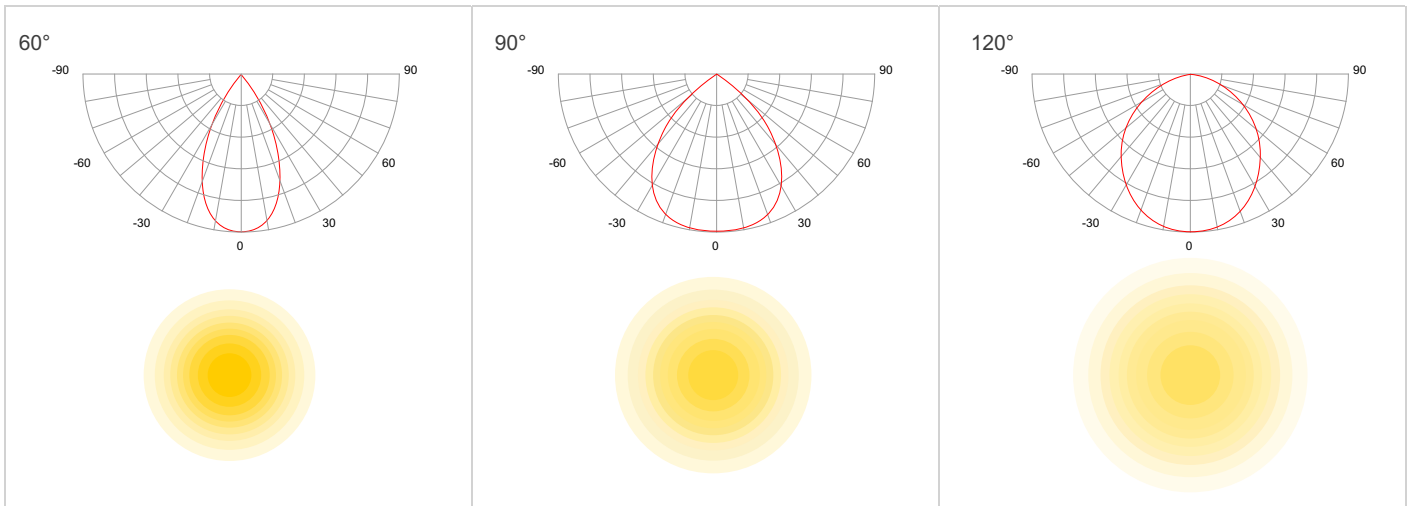

Slender LED Highbay Light

Technical Data

Model No.	SHB-80	SHB-120	SHB-160
Norminal Wattage	80W	120W	160W
Dimension(mm)	φ300*76mm	φ360*79mm	φ420*84mm
Weights	1.8kg	2.2kg	3.0kg
Input Voltage AC	AC120-277V 50/60Hz		
LED Brand	SMD 2835		
Dimming Control	1-10V		
Driver Type	Constant current(CC)		
Operating Temperature	-30 to +50°C		
Power Factor(PF)	0.9		
THD	Constant current(CC)<20%		
Safety features	Open circuit protection, Short circuit protection, Overvoltage protection		
Luminarie Efficiency(+/-5%)	145lm/w, 155lm/w, 165lm/w, 175lm/w		
Beam Angle	60°/90°/120°		
CRI	CRI>70 standard, CRI>80 optional		
CCT	3000K/4000K/5000K/5700K/6500K		
Rating	IP65 IK09		
Material	Aluminium+PC		
Installation	Loop Hanging		
Warranty	5 years		
Standard colour(s)	RAL 1127 white		
Lifetime	L70B10 >50,000h L80B10>30,000h		
Certifications	CE, RoHS		

Slender LED Highbay Light

Optional Accessories

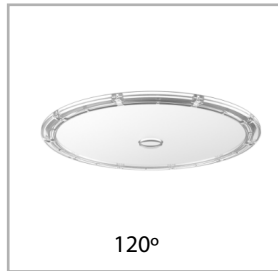
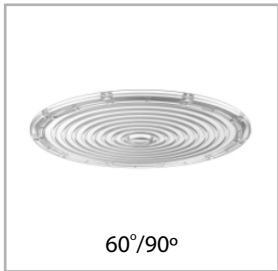

Packaging

POWER	PACKAGE SIZE	QTY/CTN	NET WEIGHT	GROSS WEIGHT	20GP	40HQ
80W	L365*W365*H130mm	1PCS/CTN	1.8kg	2.0kg	1728pcs	4138pcs
120W	L415*W415*H135mm	1PCS/CTN	2.2kg	2.8kg	1260pcs	3233pcs
160W	L485*W485*H140mm	1PCS/CTN	3.0kg	3.6kg	957pcs	2166pcs